

F-1501M_H-C

MODULAR CUBELET ICE MACHINE

Item # _____

Project: _____

Qty: _____

*AutoCad available on KCL

F-1501M_H-C

12/14

Item #13341

CUBELET DIMENSIONS

W x D x H

F-1501M_H-C
30 x 27^{1/2} x 34^{7/16}



B-500



B-700

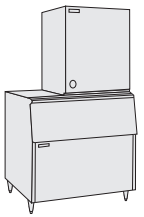

B-800

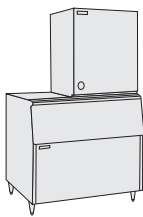

B-900

Also available on Large Bins:
B-1150SS
B-1300SS
B-1500SS
B-1650SS

*CUBELET DIMENSIONS

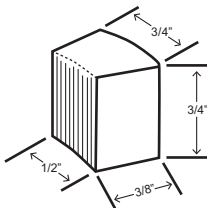

*approximate size in inches, image not to scale

F-1501MAH-C

Air-Cooled

Shown on an optional
B-900

F-1501MWH-C

Water-Cooled

F-1501MRH-C

Remote Air-Cooled



- Up to 1335 lbs. of ice production per 24 hours
- Durable stainless steel exterior
- Advanced CleanCycle24™ Design
- Removes sediment
- Cleaner ice
- Longer life and easy maintenance
- Removable air filters (Air-cooled model only)
- R-404A Refrigerant



* The F-1501MRH-C is ENERGY STAR qualified.

Warranty

Valid in United States, Canada, Puerto Rico, & U.S. Territories. Contact factory for warranty in other countries.

Three Year - Parts & Labor on entire machine. (Serial numbers Vxxxxxj and after.)

Five Year - Parts on: Compressor, air-cooled condenser coil.



© HOSHIZAKI AMERICA, INC.

618 Hwy. 74 S., Peachtree City, GA 30269

TEL 1-800-438-6087

FAX 1-800-345-1325

www.hoshizaki.com



Hoshizaki

F-150IM_H-C MODULAR CUBELET ICE MACHINE

DIMENSIONS
W x D x H
F-150IM_H-C
30 x 27^{1/2} x 34^{7/16}

- Air-cooled
- Water-cooled
- Remote Air-cooled

AIR-COOLED

Water Temp° F.	50°	70°	90°
Air Temp° F. 70°	1300	1245	1194
Air Temp° F. 80°	1145	1099	1054
Air Temp° F. 90°	1011	939	930

WATER-COOLED

Water Temp° F.	50°	70°	90°
Air Temp° F. 70°	1208	1211	1184
Air Temp° F. 80°	1158	1132	1107
Air Temp° F. 90°	1083	1096	1035

REMOTE AIR-COOLED

Water Temp° F.	50°	70°	90°
Air Temp° F. 70°	1335	1294	1258
Air Temp° F. 80°	1223	1188	1155
Air Temp° F. 90°	1123	1064	1060

UTILITY CONSUMPTION

Model Number	KWH per 100 LBS. 90/70	Potable Water Gal. per 100 lbs.
F-1501MAH-C	5.36	12.0
F-1501MWH-C	3.95	12.0
F-1501MRH-C	4.35	12.0

SPECIFICATIONS

Model Number	Condenser	Amperage	Min. Circuit Ampacity	Shipping Weight
F-1501MAH-C	Air-Cooled	15.93	20	325 lbs.
F-1501MWH-C	Water-Cooled	15.44	20	325 lbs.
F-1501MRH-C	Remote Air-Cooled	18.44	20	315 lbs.

STORAGE BINS

Model Number	Application Capacity	ARI-Rated Capacity
B-500	500 lbs.	360 lbs.
B-700	700 lbs.	550 lbs.
B-800	800 lbs.	600 lbs.
B-900	900 lbs.	660 lbs.
B-1150	1150 lbs.	N/A
B-1300	1275 lbs.	N/A
B-1500	1490 lbs.	N/A
B-1650	1605 lbs.	N/A

ELECTRICAL & PLUMBING/F-150IM_H-C

- 208-230V/60/1 (3 wire dedicated neutral for 115V)
- 20 amp Max Fuse/HACR Breaker Size
- Ice maker Water Supply Line: Minimum 1/4" Nominal ID Copper Water Tubing or Equivalent
- Ice maker Drain Line: Minimum 3/4" Nominal ID Hard Pipe or Equivalent

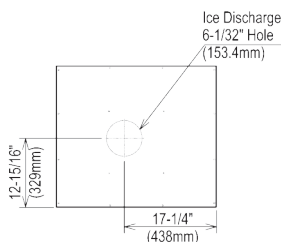

ICE DROP ZONE

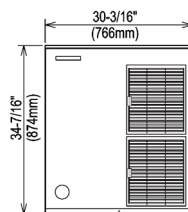

FRONT VIEW

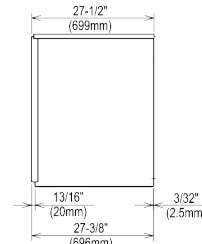

SIDE VIEW

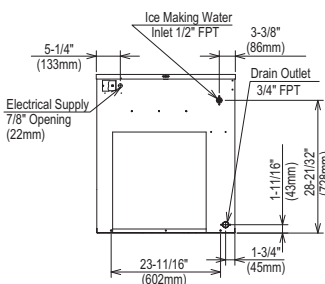

AIR-COOLED UNIT

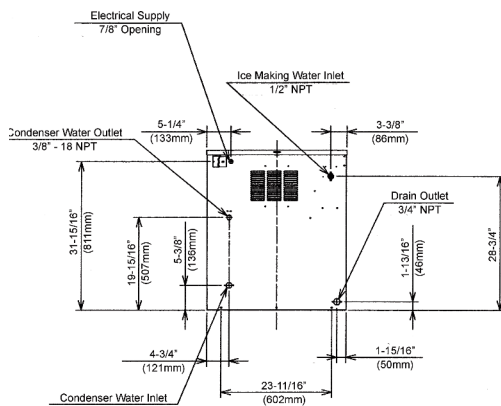

WATER COOLED UNIT

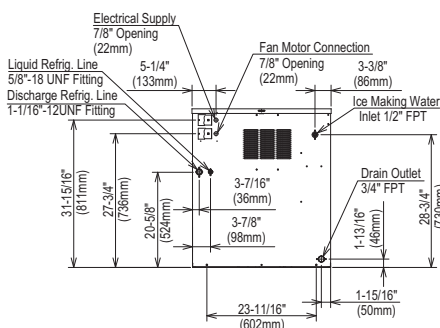

REMOTE AIR-COOLED UNIT

URC-14F Remote Condenser (Sold Separately)
For Use with F-1501MRH-C

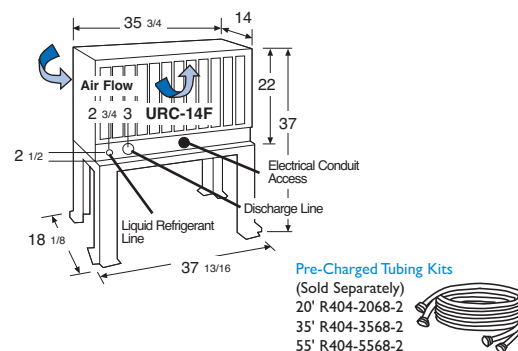

Pre-Charged Tubing Kits
(Sold Separately)
20' R404-2068-2
35' R404-3568-2
55' R404-5568-2

Voltage supply for the URC Remote Condenser
is supplied from the Ice Maker.
No additional circuit is required.

OPERATING LIMITS

- Ambient Temp Range 45 - 100°F
- Water Temp Range 45 - 90°F
- Water Pressure 10 - 113psig
- Voltage Range 104 - 127V

SERVICE

- Panels easily removed and all components accessible for service.
- Removable/cleanable air filter (Air-Cooled models only)



© HOSHIZAKI AMERICA, INC.

618 Hwy. 74 S., Peachtree City, GA 30269

TEL 1-800-438-6087

FAX 1-800-345-1325

www.hoshizaki.com

Printed in U.S.A.

